

SPECIFICATIONS & FIT TOLERANCES

CLEAT LUMBER STANDARDS

KLIMP is designed to fit standard lumber sizes. Actual dimensions are established at a 12% - 17% moisture content.

THREE STANDARD SIZES FIT MOST INDUSTRIAL APPLICATIONS

MINIMUM (WOOD TOLERANCES) MAXIMUM

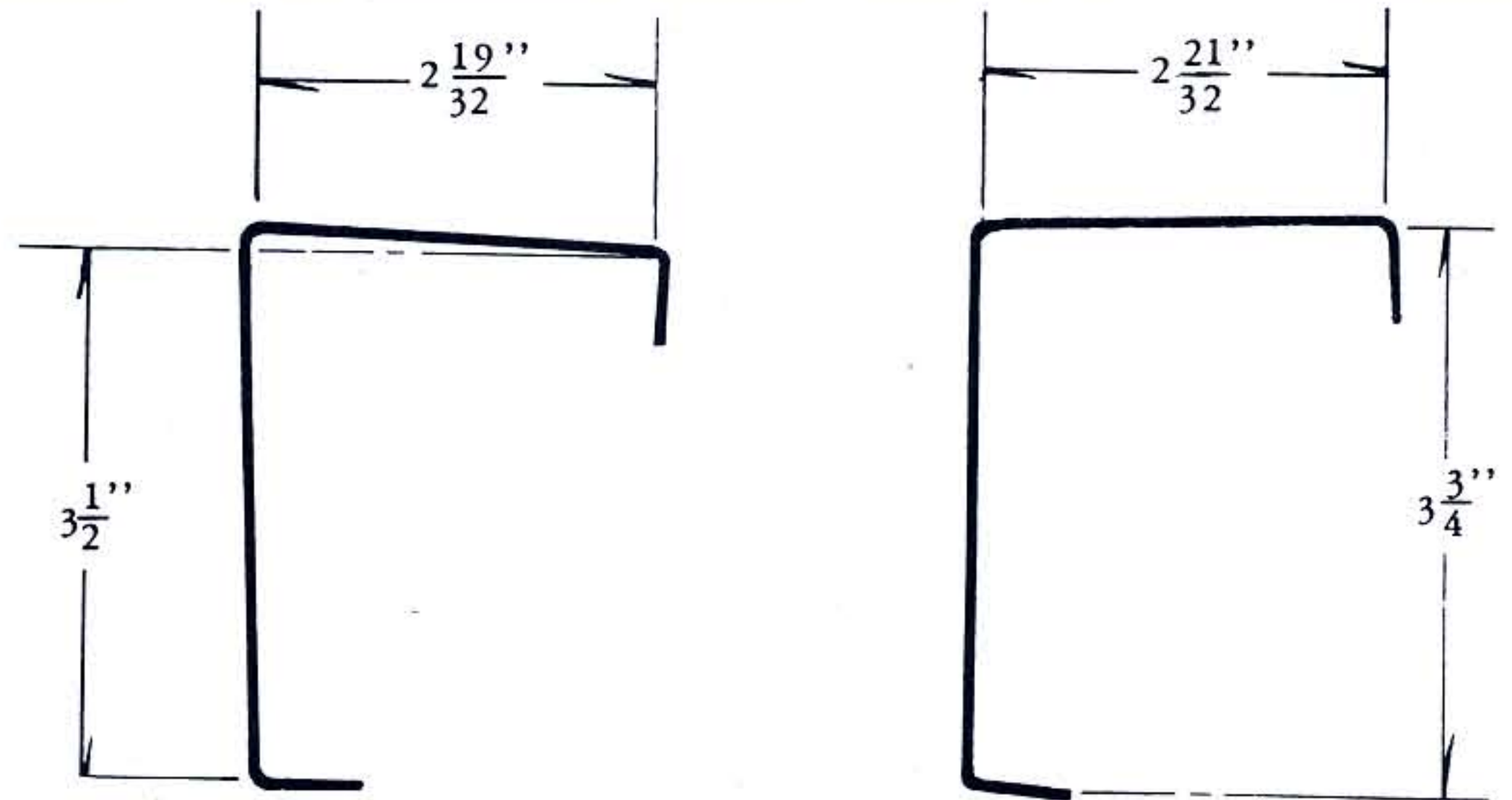
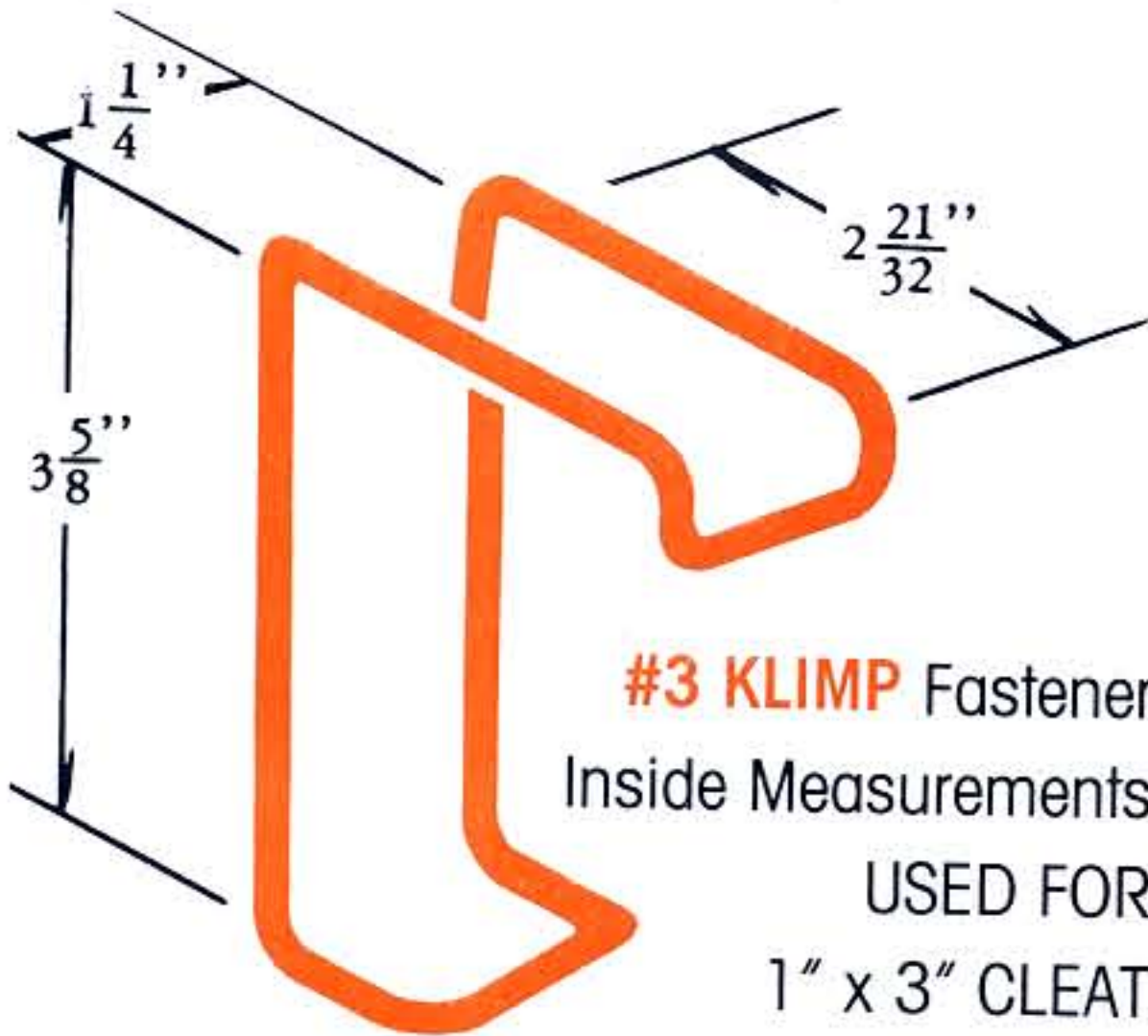

"FLEX-TIGHT" DESIGN ACCOMMODATES RANGE OF FIT TOLERANCES

KLIMP fasteners work with standard cleat lumber sizes. They fit securely around the following minimum and maximum dimensions:

PANEL CORNER

CRATE CORNER
(WITH CLEATS)

PLYWOOD CONTAINER/
CRATE CORNER
(WITH MILLED SLOTS)

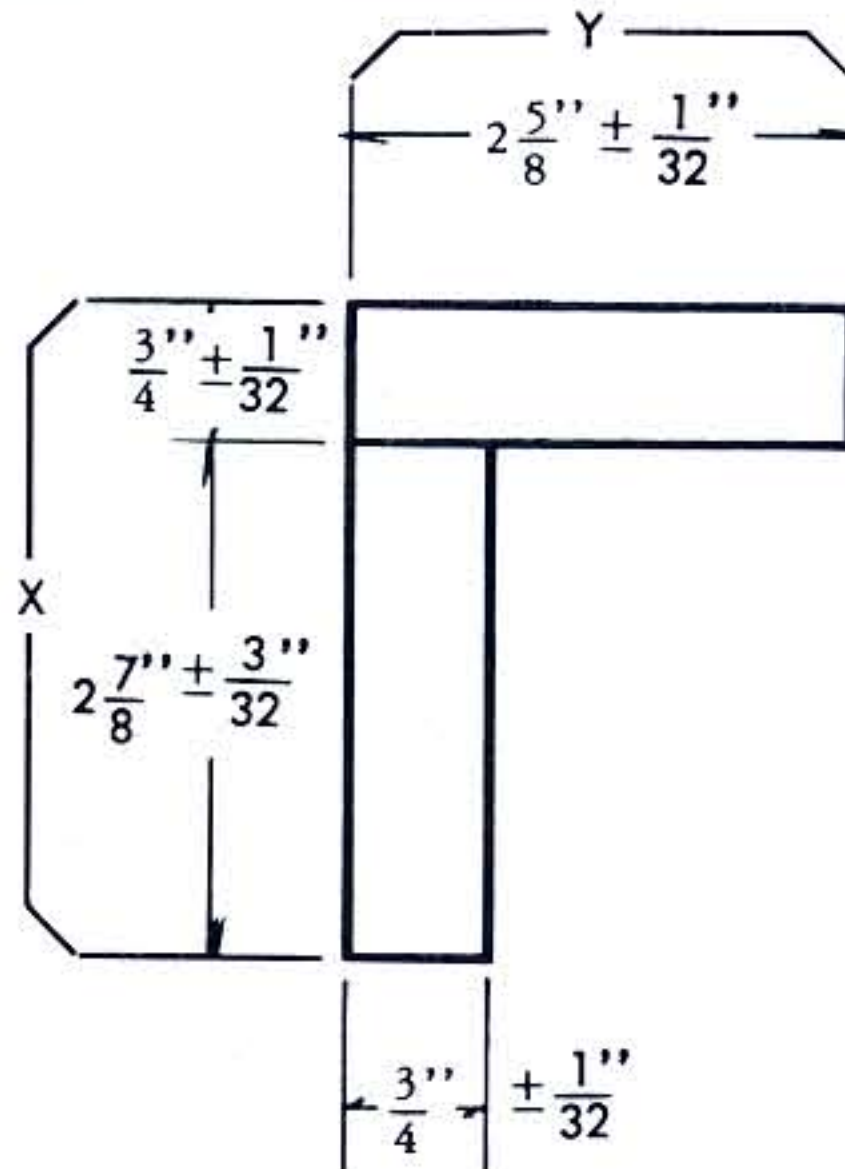
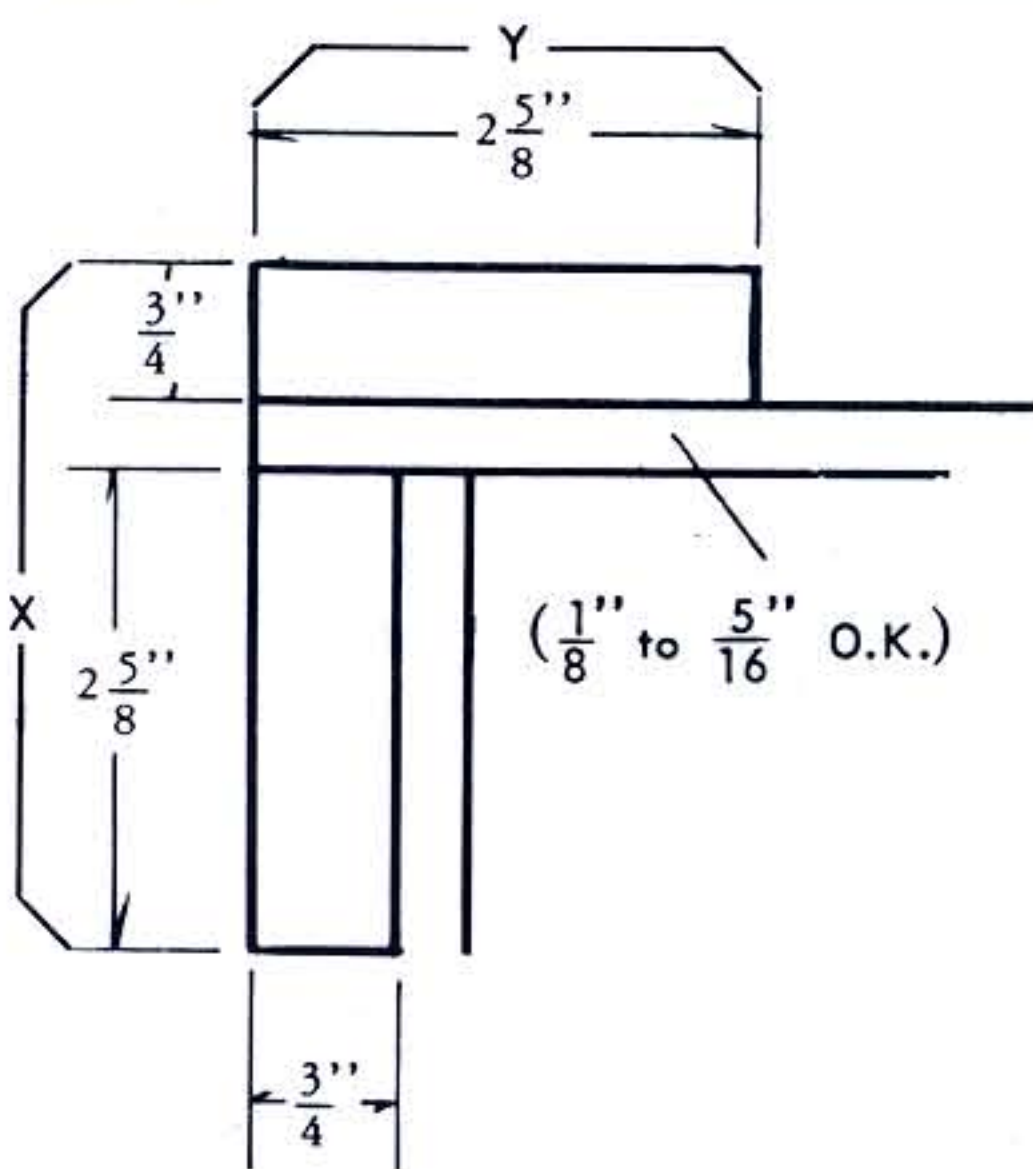

X MUST BE 3-1/2" MIN; 3-3/4" MAX.
Y MUST BE 2-19/32" MIN; 2-21/32" MAX.

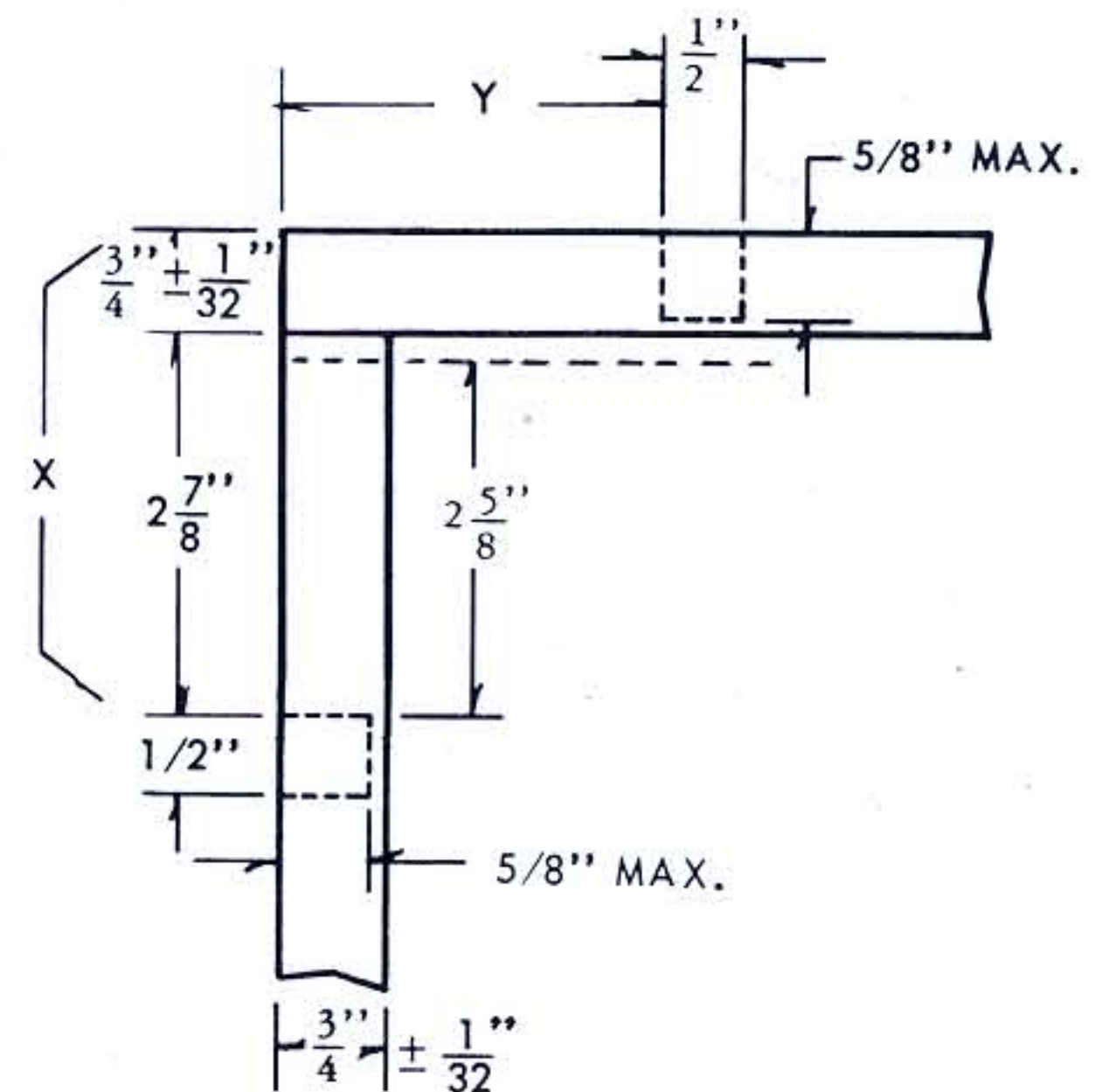

"Stack-up" of lumber tolerances should be considered in cleat dimensions.